

# MODEL VP

## Type "L" Vent Systems for Pellet Stove Applications

Metalbestos® gives you the safe, efficient, and cost-effective venting system that's engineered precisely for pellet burning stoves. Model VP has been tested and listed by Underwriters' Laboratories, Inc., in accordance with UL® - 641 Standard for Low Temperature Venting Systems, as well as the applicable requirements from UL®-103 Standard for Residential Type and Building Heating Appliance Chimneys.

Model VP, when installed according to Metalbestos® installation instructions, complies with National Safety Standards, such as NFPA-211. The system is rated for flue temperatures up to 570°F.

- Available in 3" and 4" diameters.
- Full line of fittings and full range of pipe lengths increase installation flexibility.
- Proven coupling joint connects in seconds to assure joint integrity.
- Gasketed joint design.
- Painted pipe lengths available for interior use.
- Inner wall stainless steel, outer wall paintable galvanized.
- Rolled-over male end eliminates sharp edges.
- 3" clearance to combustibles.
- Removable tee cap for inspection and cleaning.
- Internal spacing bead assures uniform insulating air space between pipe walls.

### MINIMUM CLEARANCE TO COMBUSTIBLES

Metalbestos® Model VP may be installed with a minimum 3" air space clearance to combustible surfaces, such as framing lumber, drywall, plywood, or other building materials.

Model VP may be exposed in occupied areas and painted pipe lengths help make your venting system an attractive accent to your interior decor. However, your venting system should be enclosed whenever it passes through closets, storage rooms, or accessible attics to ensure that the minimum 3" air space clearance is maintained. This is particularly true in attics where cellulose-type or other blown-in insulation materials could settle against the exposed vent pipe.

It is also advisable to provide an enclosed chase for exterior vent systems to aid in reducing condensation and to protect the pipe from cold outdoor temperatures.

Model VP features a proven joint design that allows for easy assembly. Special rope gaskets incorporated into the joint reduce leakage and help to minimize any accumulation of combustion powder residues. In addition, Model VP is listed for use with an optional, high temperature silicon sealant which enhances the integrity of the joint assembly.

Selkirk Metalbestos® is the world's leading manufacturer of venting and air distribution products for residential, commercial, and industrial use. Model VP vent for pellet stoves is just one of the family of fine products sold worldwide. Metalbestos® - it's a name you can rely on.

**NEW!**

## Thru-the-Wall Pellet Kits

All Pellet Kits come with the following

- 1 Horizontal Cap
- 1 90° Elbow
- 1 Wall Strap
- 5 One-foot Pipe Lengths
- 1 Tee with Cleanout
- 1 Wall Thimble
- 1 Pipe Adapter

Product No.	Part No.
283870	3VPKIT
284870	4VPKIT

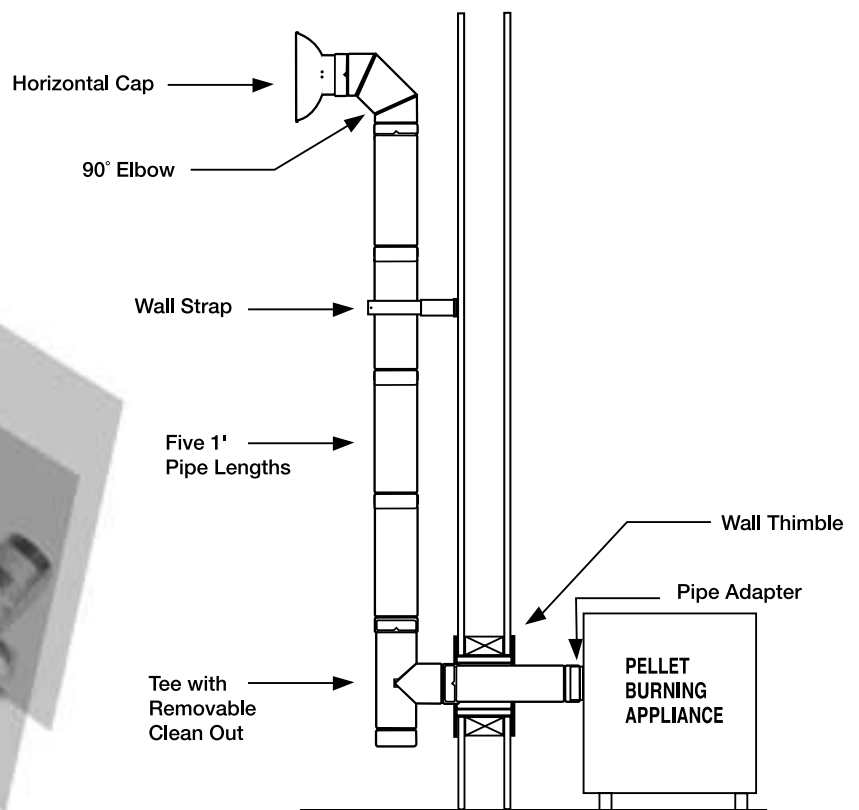

# MODEL VP PARTS GUIDE

## Vent Pipe & Vent Pipe w/Adjustable Length

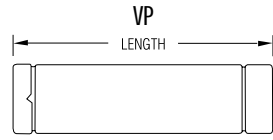

I.D.: 3", 4"  
Lengths: 1', 2', 3', 5'  
VP PIPE & FITTINGS OVERLAP 1 1/2" WHEN JOINTED HENCE,  
NET ASSEMBLED LENGTH IS 1 1/2" LESS THAN LISTED  
LENGTHS (3' AND 5' LENGTHS AVAILABLE IN BLACK)

Item Description	3" Diameter		4" Diameter	
	Product No.	Part No.	Product No.	Part No.
5' Length – Black	243060B	3VP-60B	244060B	4VP-60B
5' Length	243060	3VP-60	244060	4VP-60
3' Length – Black	243036B	3VP-36B	244036B	4VP-36B
3' Length	243036	3VP-36	244036	4VP-36
2' Length	243024	3VP-24	244024	4VP-24
12" Length	243012	3VP-12	244012	4VP-12

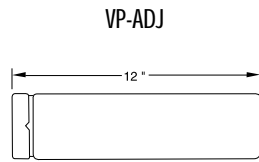

I.D.: 3", 4"  
MAX. INSTALLED LENGTH TO 1 1/2"  
ADJUST TO 8" SHORTER  
(BLACK OR UNPAINTED)

Item Description	3" Diameter		4" Diameter	
	Product No.	Part No.	Product No.	Part No.
12" Adj. Length – Black	243082B	3VP-12 adj. B	244082B	4VP-12 adj. B
12" Adj. Length	243082	3VP-12 adj.	244082	4VP-12 adj.
12" EZ Adj. – Black	243086B	3VP-EZAJ12B	244086B	4VP-EZAJ12B
12" EZ Adj.	243086	3VP-EZAJ12	244086	4VP-EZAJ12

## 90° Elbow

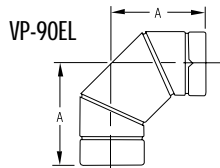

I.D.: 3" – A=5 13/16"  
4" – A=6 7/16"  
(BLACK OR UNPAINTED)

Item Description	3" Diameter		4" Diameter	
	Product No.	Part No.	Product No.	Part No.
90° Elbow – Black	243230B	3VP-90°ELB	244230B	4VP-90°ELB
90° Elbow	243230	3VP-90°EL	244230	4VP-90°EB

## Trim Plate & Exterior Shield

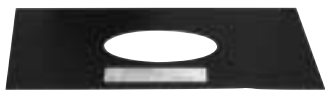

VP-TP (BLACK)

VP-ES (UNPAINTED)

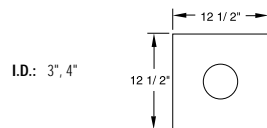

Item Description	3" Diameter		4" Diameter	
	Product No.	Part No.	Product No.	Part No.
Trim Plate – Black	243502	3VP-TP	244502	4VP-TP
Exterior Shield	243500	3VP-ES	244500	4VP-ES

## 45° Elbow

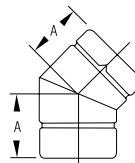

I.D.: 3" – A=3 7/16"  
4" – A=3 3/4"  
(BLACK OR UNPAINTED)

Item Description	3" Diameter		4" Diameter	
	Product No.	Part No.	Product No.	Part No.
45° Elbow – Black	243215B	3VP-45°ELB	244215B	4VP-45°ELB
45° Elbow	243215	3VP-45°EL	244215	4VP-45°EL

## Tee & Double Tee w/ Tee Cap



Item Description	3" Diameter		4" Diameter	
	Product No.	Part No.	Product No.	Part No.
Tee w/Tee Cap –Black	243100B	3VP-TSB	244100B	4VP-TSB
Tee w/Tee Cap	243100	3VP-TS	244100	4VP-TS
Double Tee w/Cap	243103	3VP-TD	244104	4VP-TD

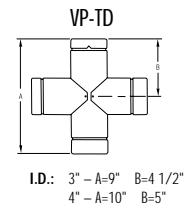
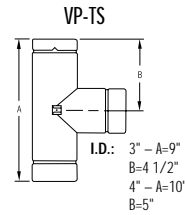

## Ceiling Support/ Firestop

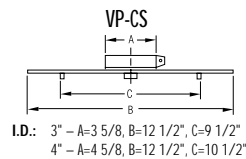
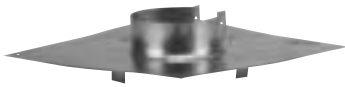

Item Description	3" Diameter		4" Diameter	
	Product No.	Part No.	Product No.	Part No.
Ceiling Support/Firestop	243410	3VP-CS	244410	4VP-CS

## Wall Bracket/ Support

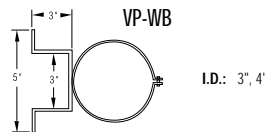
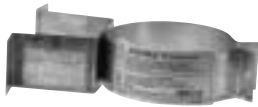

Item Description	3" Diameter		4" Diameter	
	Product No.	Part No.	Product No.	Part No.
Wall Bracket/Support	243520	3VP-WB	244520	4VP-WB

## Wall Thimble

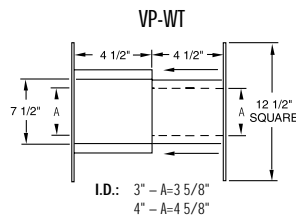
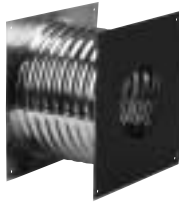

Item Description	3" Diameter		4" Diameter	
	Product No.	Part No.	Product No.	Part No.
Wall Thimble	243460	3VP-WT	244460	4VP-WT

## Tee Support

VP-WS

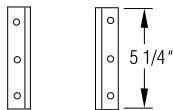

I.D.: 3", 4"

Item Description	3" Diameter		4" Diameter	
	Product No.	Part No.	Product No.	Part No.
Tee Support	243430	3/4VP-WS	3" to 4" Increaser	243304 3VP-14

## Thick Collar Pipe Connector

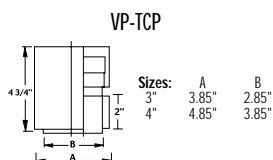

3" Diameter 4" Diameter

Item Description	3" Diameter		4" Diameter	
	Product No.	Part No.	Product No.	Part No.
Thick Collar Pipe Connector	243242	3VP-TPC	244242	4VP-TPC
Thick Collar Pipe Connector (B)	243242B	3VP-TPCB	244242B	4VP-TPCB

## Exit Cap

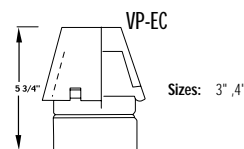

Item Description	3" Diameter		4" Diameter	
	Product No.	Part No.	Product No.	Part No.
3" Exit Cap	243803	3VP-EC		
4" Exit Cap	244803	4VP-EC		

## Pipe Connector

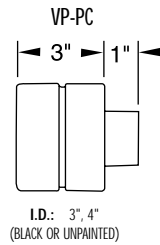

Item Description	3" Diameter		4" Diameter	
	Product No.	Part No.	Product No.	Part No.
Pipe Connector	243240	3VP-PC	244240	4VP-PC
Pipe Connector – Black	243240B	3VP-PCB	244240B	4VP-PCB

## Chimney Adapter

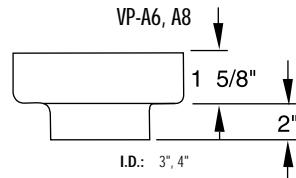

Item Description	3" Diameter		4" Diameter	
	Product No.	Part No.	Product No.	Part No.
6" SSII Adapter	243246	3VP-A6	244246	4VP-A6
8" SSII Adapter	243248	3VP-A8	244248	4VP-A8

## Storm Collar

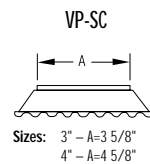

Item Description	3" Diameter		4" Diameter	
	Product No.	Part No.	Product No.	Part No.
Storm Collar	243810	3VP-SC	244810	4VP-SC

## Adjustable Flashing

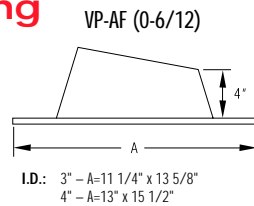
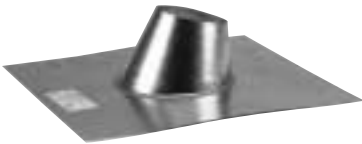

Item Description	3" Diameter		4" Diameter	
	Product No.	Part No.	Product No.	Part No.
Adj. Flashing	243825	3VP-AF	244825	4VP-AF

## Tall Cone Flashing

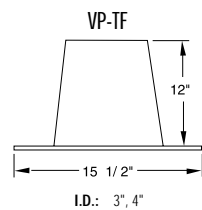

Item Description	3" Diameter		4" Diameter	
	Product No.	Part No.	Product No.	Part No.
Tall Cone Flashing	243815	3VP-TF	244815	4VP-TF

## Horizontal & Vertical Termination

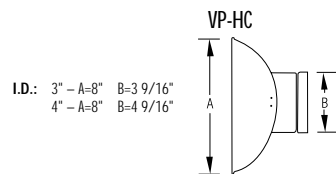

Item Description	3" Diameter		4" Diameter	
	Product No.	Part No.	Product No.	Part No.
Vertical Termination	243800	3VP-VC	244800	4VP-VC
Horizontal Termination	243805	3VP-HC	244805	4VP-HC

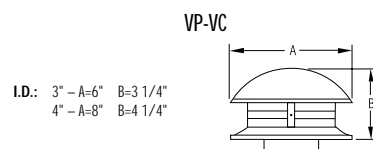

# COMMON MODEL VP INSTALLATIONS

The following illustrations detail the most common types of Model VP installations and the variety of parts required.

## Horizontal Exit Termination

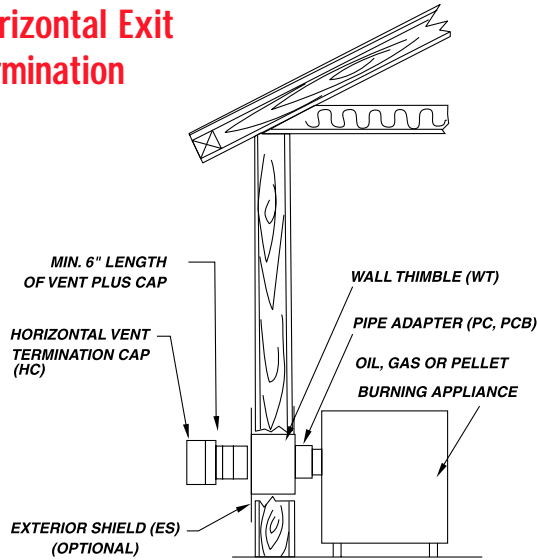

## Through the Ceiling Rear Vent

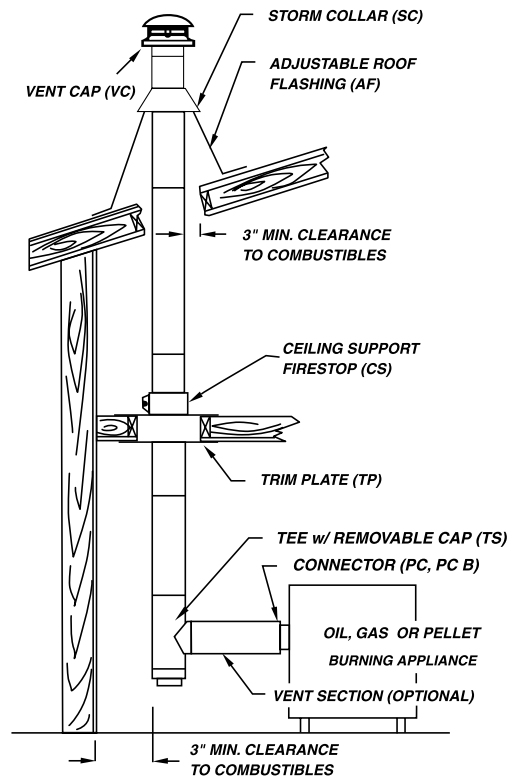

## Through the Ceiling Top Vent

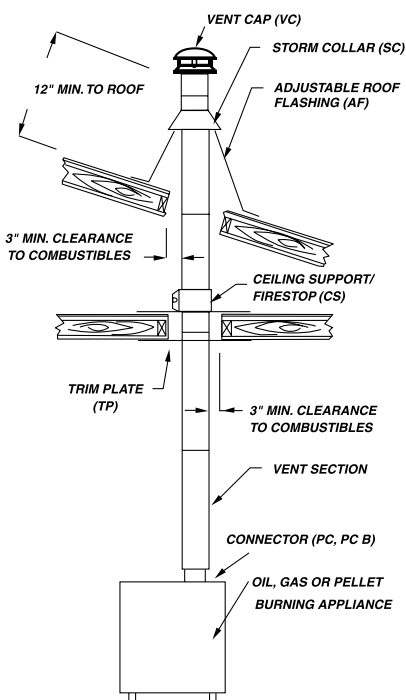

## Through the Wall Rear Vent

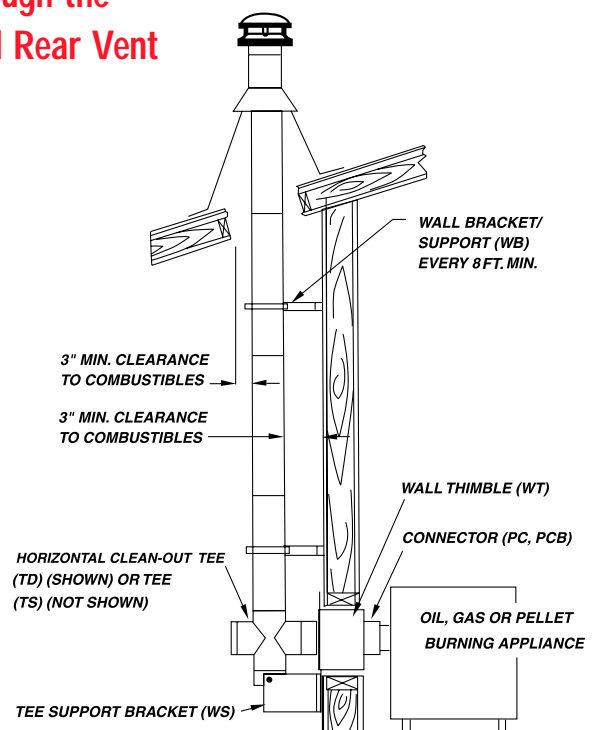

#### WORLD HEADQUARTERS

14801 Quorum Drive  
Dallas, Texas 75254-7584  
(800) 992-8368 (VENT)  
Fax: (972) 560-2258  
www.selkirkinc.com

#### SALES OFFICES & CUSTOMER SERVICE

##### UNITED STATES

14801 Quorum Drive  
Dallas, Texas 75254-7584  
(800) 992-VENT (8368)  
Fax: (972) 560-2258  
Toll Free Fax: (877) 393-4145

##### CANADA

375 Green Road  
Stoney Creek, Ontario  
Canada L8E 4A5  
(905) 662-6600  
Fax: (905) 662-5352  
www.selkirkcanada.com

#### RESEARCH & DEVELOPMENT/ MANUFACTURING

##### UNITED STATES

St. Rt. 93 N. & Sutton Rd.  
Logan, Ohio 43138  
(740)385-5666  
Fax: (800)972-1421

1820 E. Fargo Ave.  
Nampa, Idaho 83687-6824  
(208)467-7411  
Fax: (208)467-7412

7571 West Highway 153  
P.O. Box 427  
Winters, Texas 79567  
(915)754-4571  
Fax: (915)754-4764

##### CANADA

1400 California Ave.  
P.O. Box 160, Brockville, Ontario  
Canada K6V 5V3  
(613)342-6655  
(800)267-8178  
Fax: (613)342-2735

##### MEXICO

Justo Sierra Y 2 da Avenida  
Ojinaga, Chihuahua, Mexico  
011 52 14 532 884/85  
Fax: 011 52 14 532 886

#### TECHNICAL SUPPORT

##### REGISTER, GRILLE & DIFFUSER

(214) 390-8100  
Fax: (214) 390-8200  
Email: Airmatesupport@selkirkinc.com

##### CHIMNEY & VENTING

(800) 848-2149 ext. 212  
Fax: (740) 385-2483  
Email: Metalbestossupport@selkirkinc.com

# PLATINUM SERIES™

## CHIMNEY SYSTEMS

**ULTRA-TEMP™ HT** - Tested up to 2100'  
Stainless Steel

**ULTRA-TEMP™** - Tested up to 1700'  
Stainless Steel

**GALVA-TEMP™ HT** - Tested up to 2100'  
Galvanized

 **SELKIRK**  
www.selkirkinc.com  
800.992.VENT (8368)

### FIELD TECHNICAL SERVICES

To assist users of our products, Metalbestos® venting specialists throughout the U.S. conduct field investigations to help solve unusual venting problems. They also give assistance on building code and materials approval questions.

For complicated projects, our technical staff can prepare detailed take-offs from architectural drawings. And, the Selkirk seminars are still another valuable field aid available to contractors, building officials and utility service people.

### FACTORY ENGINEERING SERVICES

The Selkirk venting laboratory is one of the most advanced in the world and has conducted hundreds of tests to solve unusual venting problems. The Selkirk engineering staff provides design services for special product applications and for installations requiring complex or unusual manifold systems.

### TECHNICAL AIDS

The Metalbestos® Sizing Handbook is a comprehensive guide to correct venting with Metalbestos® gas vent and chimney parts. This handbook contains detailed vent capacity tables for individual or combined systems, complete design information and illustrations for each type of venting problem.

In addition, the company provides complete parts catalogs, price sheets and illustrated installation instructions for all products.



Selkirk L.L.C. offers customers a Lifetime Limited Warranty on all Metalbestos Venting Systems, subject to certain warranty conditions.

For a copy of the warranty, please contact us or visit our website.

[www.selkirkinc.com](http://www.selkirkinc.com)  
800-992-8368 (VENT)

 **SELKIRK**

SELKIRK L.L.C. is a leading manufacturer of venting products for residential, commercial and industrial applications. Current operations include locations in the United States, Canada and Mexico. SELKIRK L.L.C. has been supplying the finest venting products for over 75 years.