



Selkirk gas vent parts LISTED and produced under the Factory Inspection and Follow-up program of Underwriters' Laboratories, Inc. carry the LISTING MARK illustrated here.



CAUTION: WEAR GLOVES WHILE HANDLING METAL PARTS TO AVOID PERSONAL INJURY. SHARP EDGES OR PROJECTIONS CAN CUT YOU.

WARNING

Failure to follow the installation instructions could cause FIRE, CARBON MONOXIDE POISONING, OR DEATH. If you are unsure of installation requirements, call the Phone Number listed on the instructions, 1.800.433.6341 or visit www.selkirkcorp.com.

1. GAS VENT DESIGNATIONS/Joint METHOD

These instructions describe installation of the following sizes of Selkirk, Type B Gas Vent Pipe and associated parts.

Model	Size	Means of Joining	Minimum Airspace Clearance
RV	3 - 8"	Integral Snap Lock Coupler	1"
QC	10 - 24"	6 sheet metal screws/joint	1"
QC	26 - 48"	6 sheet metal screws/joint	2"

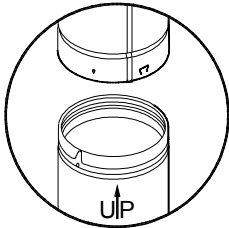

FIG. 1 3" - 8" RV

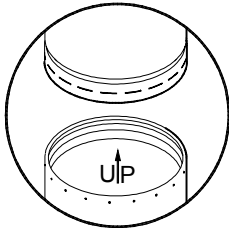

FIG. 2 10" - 48" QC

All joints in Selkirk gas vents must be secured using the appropriate method. ("Snap Lock") feature for sizes 3" - 8" (Fig. 1) and sheet metal screws for sizes 10"-48" (Fig. 2). To use the Snap Lock feature, orient sections as shown in Fig. 1 and force adjacent pieces together until "SNAP" is heard, indicating full/proper joint engagement.

To secure Model QC joints, orient as shown in Fig. 2. Push together until slots in the inlet end overlap the holes in the outlet end. Insert 6 (max. 1/2" long) screws, evenly spaced around perimeter.

NOTE: Some local jurisdictions require a supplemental screw(s) at joints to prevent disengagement of the joint. Although not required under the terms of the UL Listing because of the integral couplers, screws are permitted to be installed at the joints in 3" through 8" vent. In such case, the screws should be located approximately 1/4" from overlapped edge and must be maximum 1/4" in length so they do not pierce or deform the inner liner.

A new Lock-Tab® feature provides the equivalent of using a screw for this purpose since, once engaged (with finger or thumb until it bends into the groove in the top/ outlet end of the adjacent piece), it prevents the pipes from being disengaged unless the tab is pried back out and dimples aligned.

2. TYPES OF APPLIANCES AND BUILDINGS

Type B Gas Vents are for venting of listed (L.P. or natural) gas-burning appliances equipped with draft hoods and other Listed gas appliances specified for use with Type B gas vents. These appliances include (but are not limited to) the following types: furnaces, boilers, water heaters, room heaters, unit heaters, duct furnaces, floor furnaces, and decorative appliances.

DO NOT USE Type B Gas Vent for wall furnaces "Listed" for use with Type BW Gas Vents only, incinerators and appliances Listed for use with chimneys only, combination gas-oil burning appliances, and appliances which may be converted readily to the use of solid or liquid fuels. DO NOT USE Type B Gas Vent for Category II, III, or IV appliances, or for any gas-burning appliance which requires either a pressure-tight or liquid-tight venting system.

All sizes of Selkirk Type B Gas Vent may be used in single and multistory buildings. All Type B Gas Vents may be used for both individual and multiple appliance venting. Selkirk Type B Gas Vents are to be installed and used in accordance with the "National Fuel Gas Code", NFPA 54, the "Standard for Chimneys, Fireplace and Venting Systems", NFPA 221, the "International Fuel Gas Code" and/or applicable local/regional codes. Selkirk Type B Gas Vent is also suitable for use in existing, otherwise unused and new

Round Type B Gas Vent INSTALLATION INSTRUCTIONS

masonry chimneys to protect the chimney from damaging effects of moist combustion products from the appliances listed above. NEVER USE Selkirk Type B Gas Vent on any appliance that is not listed and approved for venting with Type B gas vent.

A NOTICE SHOULD BE POSTED near the point where the Gas Vent is connected to the appliance, with the following wording: "Connect this Gas Vent only to gas burning appliances, as indicated in the installation instructions. Do not connect to incinerators, or liquid or solid fuel burning appliances".

3. AIR SUPPLY

Gas appliances must have an adequate air supply for combustion, vent operation, and ventilation. (See Table below) Special provisions for bringing in outside air may be necessary in tight buildings or when appliances are in small rooms. Consult local building codes, or NFPA 54, "National Fuel Gas Code" for air supply requirements.

REQUIRED FREE AREA FOR EACH OPENING OR DUCT, SQUARE INCHES BASED ON TOTAL INPUT*			
APPLIANCE TYPES IN ROOM			
Air Supply Method	Draft Hood (NAT)	Combination (FAN + NAT)	Fan-Assisted (Fan Only)
A. All Air From Inside Building	sq. in. = $\frac{\text{Total Input}}{1000}$	$\frac{\text{Total Input}}{1000}$	$\frac{\text{Total Input}}{2000}$
B. All Air From Outdoors Through Wall Openings	sq. in. = $\frac{\text{Total Input}}{4000}$	$\frac{\text{Total Input}}{4000}$	$\frac{\text{Total Input}}{8000}$
C. All Air From Outdoors Through Ducts	sq. in. = $\frac{\text{Total Input}}{2000}$	$\frac{\text{Total Input}}{2000}$	$\frac{\text{Total Input}}{4000}$
D. All Air From Ventilated Attic	sq. in. = $\frac{\text{Total Input}}{4000}$	$\frac{\text{Total Input}}{4000}$	$\frac{\text{Total Input}}{8000}$
e. All Air From Crawl Space Out To Attic	sq. in. = $\frac{\text{Total Input}}{4000}$	$\frac{\text{Total Input}}{4000}$	$\frac{\text{Total Input}}{8000}$

* Total input - Total of all appliance nameplate input ratings.

COMBINED VENT SYSTEM USING TYPE B PARTS STARTING WITH DRAFT HOOD CONNECTORS

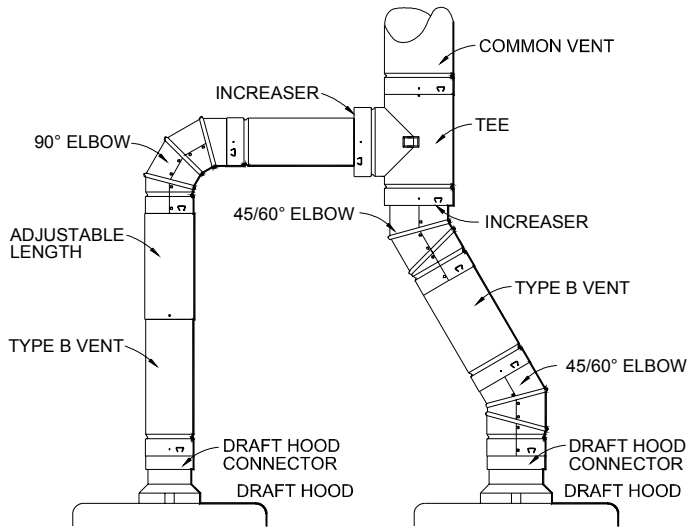

FIG. 3

4. VENT CONNECTOR TYPE AND SIZE

Selkirk Gas Vent pipe meets all building code and safety standards for use as gas appliance vent connectors. (See Fig. 3). Correct selection of connector and vent size is detailed in the Selkirk MetalBest Gas Vent and Chimney Sizing Handbook, the "National Fuel Gas Code" (NFPA 54), and local/regional codes.

Draft hood connectors must be attached to the appliance outlet with screws. Single wall connectors, if used must be secured to the appliance, to the gas vent, and at all joints with 3 sheet metal screws per joint. Attachment of vent to non-metallic outlets should be per appliance manufacturer recommendations.

Indoors, gas vent sizes 3" through 8" may be supported and firestopped using the Support Assembly (plate plus clamping band) or by using the clamping band with a generic 26 gauge or heavier plate (if space requirements dictate). (Fig. 9). Cut away all floors and ceilings to 1" minimum air space clearance. After nailing the plate to flooring, slide clamp band over pipe and pipe through hole to proper elevation. Secure band to pipe with tabs and 1/4" screws (provided) so weight of pipe rests on plate. Insure 1" minimum airspace is established and maintained. The support plate will support 35 feet of vent. Vertical runs fire stopped at 8 to 10 foot intervals need only be supported near the bottom.

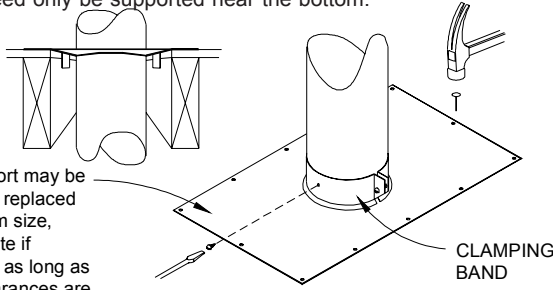

FIG. 9 FIRESTOP/SUPPORT ASSEMBLY

Tees used as vent inlets may be supported by sheet metal plates or brackets. Plumbers tape may be used to support both horizontal and vertical piping. Short vents with less than 6 feet of vertical pipe below the flashing may be suspended from the flashing. (The pipe may be supported by the storm collar resting on the top of the flashing.) Use 1/4 inch long sheet metal screws to attach the storm collar to the pipe at the appropriate place. Gas vents supported only by the flashing must be guyed above the roof to withstand snow and wind loads. All gas vents extending above the roof more than 5 feet must be securely guyed or braced.

Selkirk sizes 10"-24" Gas Vents may be supported by using a split plate support which fits around the groove near the ends of the pipe and rests on masonry or a metal frame (See Fig. 10-A). Use bucket support for 26" and larger sizes.

Suitable structural iron bands constructed from 16 gauge steel or heavier, may be used for the same purpose.

When offsets are necessary, adequate support above and below the offset is required. In addition, securing the offset elbow with three maximum 1/4" long sheet metal screws is recommended.

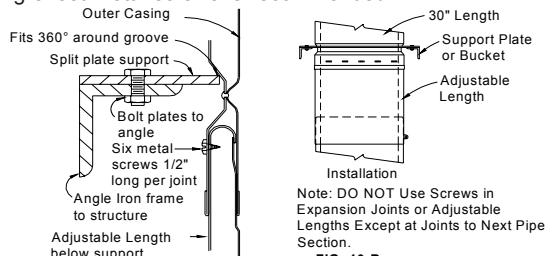

FIG. 10-A SPLIT PLATE SUGGESTED SUPPORT DETAIL

FIG. 10-B TYPICAL EXPANSION JOINT BELOW EACH SUPPORT

Note: DO NOT Use Screws in Expansion Joints or Adjustable Lengths Except at Joints to Next Pipe Section.

11. FLASHING

The roof opening should be located and sized such that the vent is vertical and has the required air space clearance. The Tall Cone Flashing is for flat roofs only (See Fig. 11-A). It is nailed in place through all four sides of the base flange. The Adjustable Roof Flashing (See Fig. 11-B) is positioned with the lower portion of the base flange over roofing material and the upper portion of the base flange under the roofing material. Nail through only the upper portion and sides of the base flange. (DO NOT nail through lower flange.) Use nails with a neoprene washer, or cover the nail heads with a silicone sealant. Finish roofing around the flashing, covering the sides and upper areas of the flange with roofing material.

12. VENT TERMINATION

Gas vent piping must extend through the flashing to a height above the roof determined by Rule I or Rule II shown below. A storm collar is installed on the vent pipe over the opening between pipe and flashing. Silicone sealant is used over the joint between pipe and storm collar. The top is securely attached to the gas vent using the proper method for the model of pipe. (See sections 13 and 14.)

Rule I - Tops for gas vents 12" and smaller.

The top is suitable for installation on listed gas vents terminating a sufficient distance from the roof so that no discharge opening is less than 2 feet horizontally from the roof surface, and the lowest discharge opening will be no

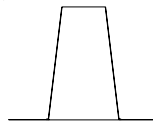

FIG. 11-A TALL CONE FLASHING FOR FLAT ROOFS ONLY

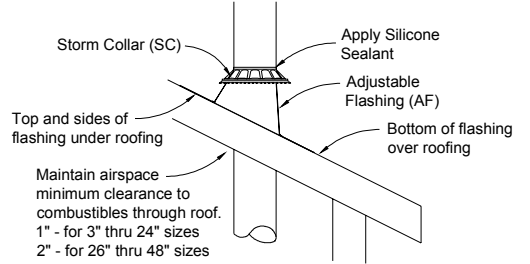

FIG. 11-B ELEMENTS FOR PROPER ROOF FLASHING INSTALLATION

closer than the minimum height specified in Fig. 12-B. These minimum heights may be used provided that the vent is not less than 8 feet from any vertical wall.

Rule II - Tops for gas vent sizes 14" and larger.

For installations other than covered by the table (Fig. 12-B), or closer than 8 feet to any vertical wall, the top shall be not less than 2 feet above the highest point where the vent passes through the roof and at least 2 feet higher than any portion of a building within 10 feet. Vent tops 14" and larger must comply with Rule II regardless of roof pitch.

These rules were established on the basis of tests conducted in accordance with American National Standard ANSI/UL 441.

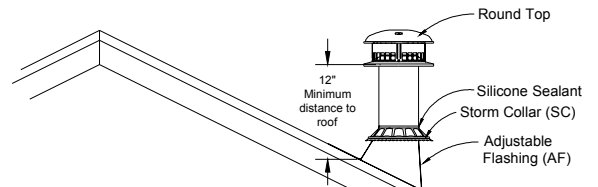

FIG. 12-A FOR ROOF PITCH OF 7/12 OR LESS

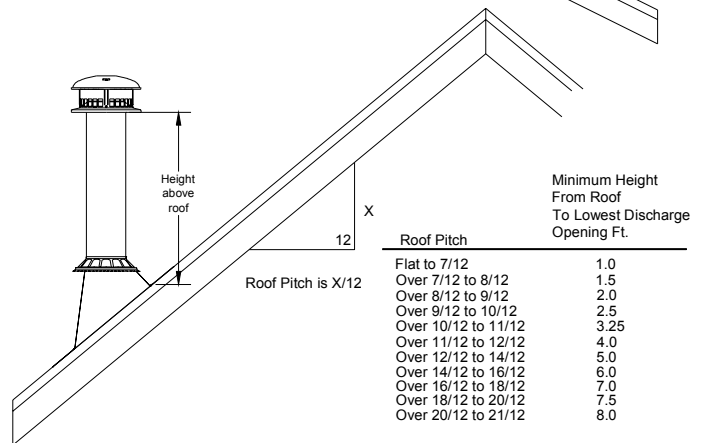

FIG. 12-B LOCATION RULES FOR FLAT TO 21/12 PITCH

13. 3"-8" TOP INSTALLATION

Selkirk Round tops (for pipe sizes 3"-8") have a spring clip which engages and locks automatically when the top is pushed into the upper end of the pipe. (See Fig. 13-A.) The top will also fit any single wall metal pipe having full nominal inch dimensions. (Never use single wall metal pipe where Type B Gas Vent is required). To attach securely, bend a one inch length of the pipe upper end inward about 1/8". The spring clip will lock under this bent edge. (See Fig. 13-B.) To remove the top from any pipe, pull up evenly on opposite sides of the skirt of the top.

14. 10"-24" TOP INSTALLATION

The Selkirk Round Tops (for pipe sizes 10"-24") feature an expanding collar which clamps to the inside of the pipe and any other sheet metal of similar nominal size. To install, loosen screw on top of collar and squeeze the bottom so that it will enter the pipe easily (See Fig. 14-A). Press down evenly on the skirt until it contacts the upper end of the pipe (See Fig. 14-B). Tighten the screw to expand the collar against the pipe inner (See Fig. 14-C). DON'T OVERTIGHTEN! Attempt to lift skirt to ensure top is secure.

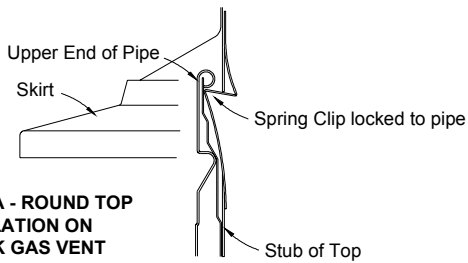

FIG. 13-A - ROUND TOP INSTALLATION ON SELKIRK GAS VENT

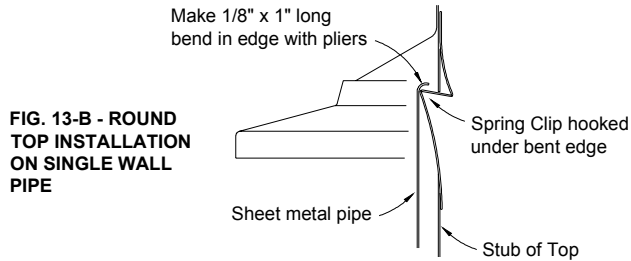

FIG. 13-B - ROUND TOP INSTALLATION ON SINGLE WALL PIPE

3\"/>

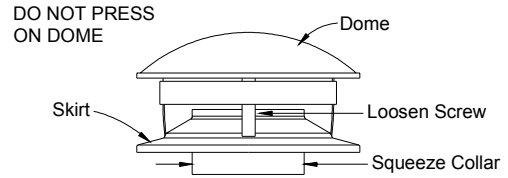

FIG. 14-A

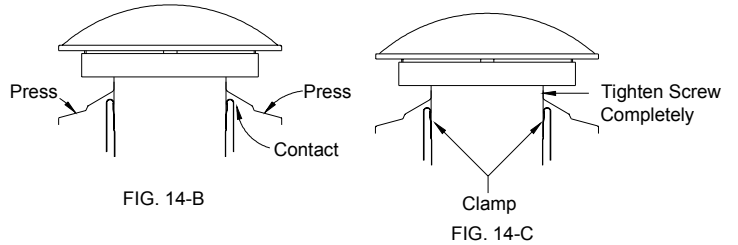

FIG. 14-B

FIG. 14-C

10\"/>

15. CHECKING VENT OPERATION

Complete all gas piping, electrical, and vent connections. After adjusting the appliance and lighting the main burner, allow a couple of minutes for warm-up. Hold a lighted match just under the rim of the draft hood relief opening (see Fig. 15). Proper venting will draw the flame toward or into the draft hood. Improper venting, indicated by escape or spillage of burned gas, will cause match to flicker or go out. Smoke from a cigarette will also be pulled into the draft hood if the vent is drawing properly and flow away if not. For fan assisted appliances, which have no draft hood, no such check is available. However, fan assisted appliances are designed to shut down if excessive pressure is detected at the outlet. If this occurs it may be an indication that the system is not venting properly.

16. PAINTING

To prolong the life and appearance of the galvanized steel outer casing and other parts of Selkirk Gas Vents located outdoors, use proper painting

procedure at time of installation. Remove oil and dirt with a solvent. Paint first with a good quality zinc primer or other primer recommended for use on galvanized steel. Next apply an appropriate finish coat. Ordinary house paints applied directly to galvanized steel may not adhere well and do not prevent underfilm corrosion which leads to paint loosening and peeling.

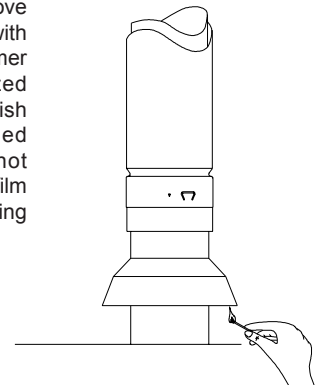

FIG. 15 MATCH TEST FOR SPILLAGE

These instructions should be observed when installing Selkirk Gas Vents. Engineering methods for design and sizing of all Selkirk Gas Vents are provided in the "Selkirk MetalBest Gas Vent and Chimney Sizing Handbook". Following these methods will assure safe and complete removal of combustion products. For installation of Selkirk Oval Gas Vents, see separate instruction sheet.